

(Installation performed on Polaris RZR XP[®] Turbo)

Liability Statement

SuperATV's[®] products are designed to best fit user's ATV/UTV under stock conditions. Adding, modifying, or fabricating any factory or aftermarket parts will void any warranty provided by SuperATV[®] and is not recommended. SuperATV's[®] products could interfere with other aftermarket accessories. If user has aftermarket products on machine, contact SuperATV[®] to verify that they will work together.

Although SuperATV[®] has thousands of satisfied customers, user should be aware that installing lift kits, long travel, or suspension kits, tires, etc. will change the ride of machine and may increase maintenance and part wear. Operating any off-road machine while, or after, consuming alcohol and/or drugs increases risk of bodily harm or death. No warranty or representation is made as to this product's ability to protect user from severe injury or death. SuperATV[®] urges operators and occupants to wear a helmet and appropriate riding gear at all times.

By purchasing and installing SuperATV[®] products, user agrees that should damages occur, SuperATV[®] will not be held responsible for loss of time, use, labor fees, replacement parts, or freight charges. SuperATV[®], nor any 3rd party, will not be held responsible for any direct, indirect, incidental, special, or consequential damages that result from any product purchased from SuperATV[®]. The total liability of seller to user for all damages, losses, and causes of action, if any, shall not exceed the total purchase price paid for the product that gave rise to the claim.

SuperATV[®] will warranty only parts provided by SuperATV[®]. Any damage or problems with OEM housings, bearings, seals, or other manufacturers' products will not be covered by SuperATV[®]. SuperATV[®] parts and products are not warranted if item was not installed properly, misused, or modified.

Installing, adding, modifying, or fabricating any factory or aftermarket product to your ATV/UTV may violate certain local, state, and federal laws. Be advised that laws vary depending on town, city, county, state, etc. Use of certain products on public streets, roads, or highways may be in violation law. The Buyer is solely and exclusively legally and personally responsible for any violation of the law by the installation or use of the product. You must abide by all local, state, and federal laws, including but not limited to vehicle safety, traffic laws, and ordinances. It is your responsibility to know the laws and how they apply to you.

The Buyer is responsible to fully understand the capability and limitations of his/her vehicle according to manufacturer specifications, warnings and instructions and agrees to hold SuperATV[®] harmless from any damage resulting from failure to adhere to such specifications, warnings and/ or instructions. The Buyer is also responsible to obey all applicable federal, state, and local laws and ordinances when operating his/her vehicle while using this product, and the Buyer agrees to hold SuperATV[®] harmless from any violation thereof.

Need help with your installation?



sales@superatv.com



www.superatv.com



1-855-743-3427



8:00am - 9:00pm EST M-Th
8:00am - 7:00pm EST Friday
9:00am - 2:00pm EST Saturday

Read instructions and view illustrations before beginning.

Thank You

For Choosing



kit contents continue on following page

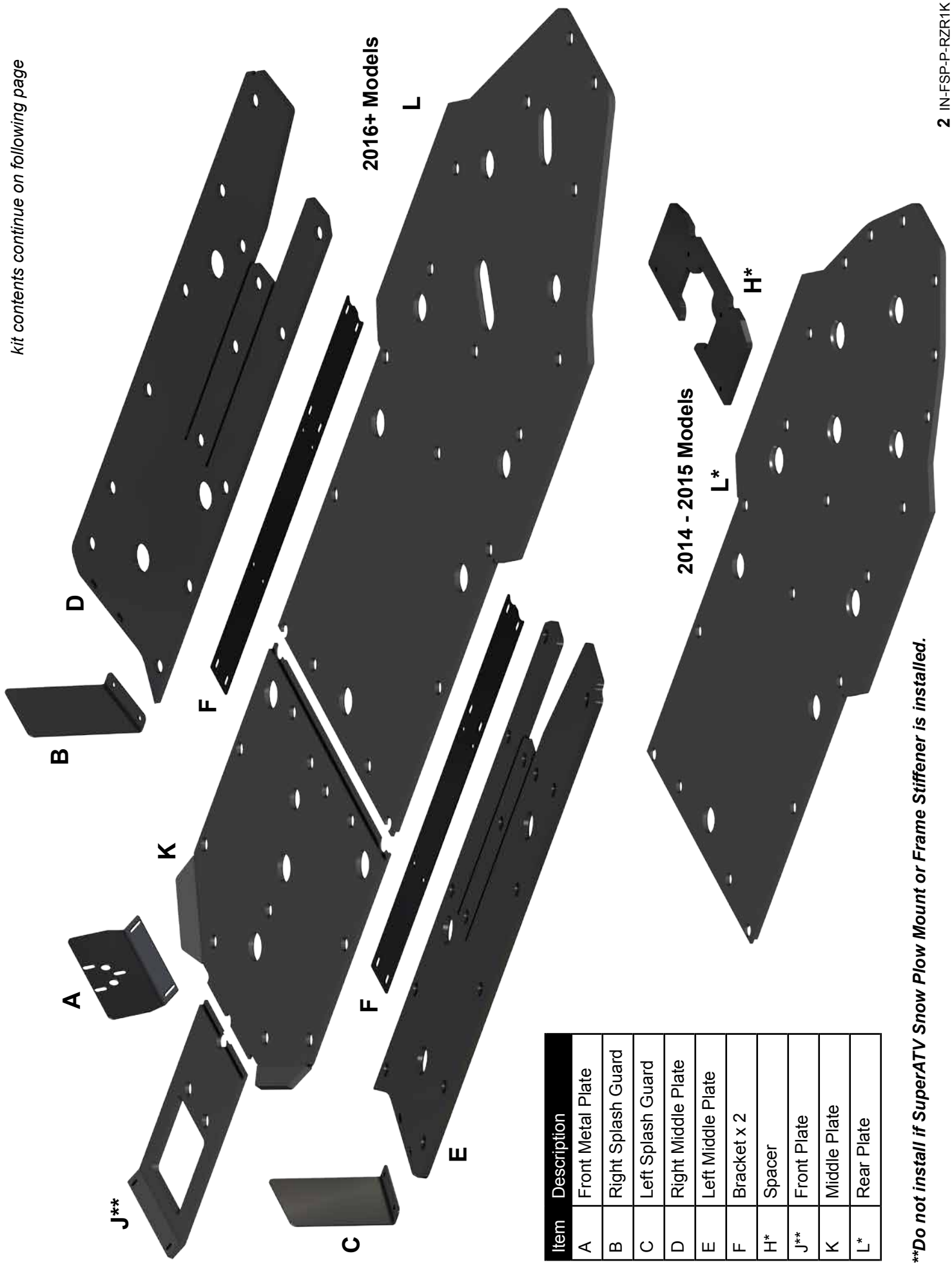

2016+ Models

2014 - 2015 Models

| Item | Description |
|------|--------------------|
| A | Front Metal Plate |
| B | Right Splash Guard |
| C | Left Splash Guard |
| D | Right Middle Plate |
| E | Left Middle Plate |
| F | Bracket x 2 |
| H* | Spacer |
| J** | Front Plate |
| K | Middle Plate |
| L* | Rear Plate |

****Do not install if SuperATV Snow Plow Mount or Frame Stiffener is installed.**

kit contents continued

7x  M8-1.25 x 35mm Lg. BHCS

2x  M5-.80 x 25mm Lg. BHCS

12x  M6-1.0 x 20mm Lg. FHCS

Discard any remaining hardware.

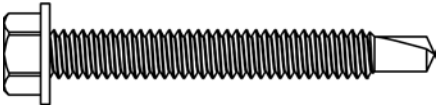
4x  1/4"-20 x 2" Lg. Self Tapping

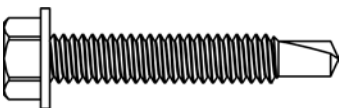
27x  1/4"-20 x 1-1/2" Lg. Self Tapping

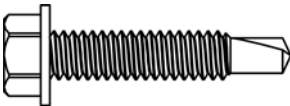
6x  1/4"-20 x 1-1/4" Lg. Self Tapping

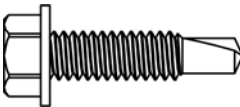
5x  1/4"-20 x 1" Lg. Self Tapping

7x  M8-1.25 Nylock Nut

12x  M6 Clip Nut

2x  M5-.80 Jam Nut

2x  Spacer

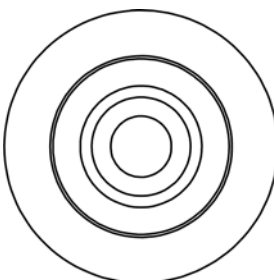
55x  Bowl Washer

Bowl Washers will be used when installing Plates unless noted

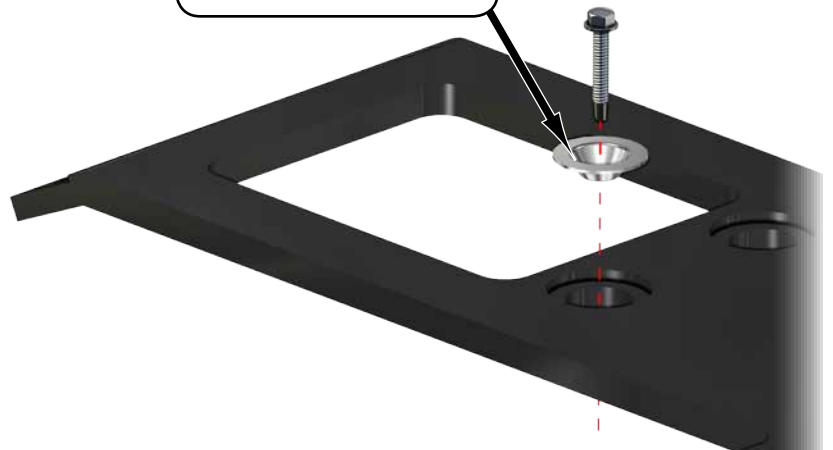
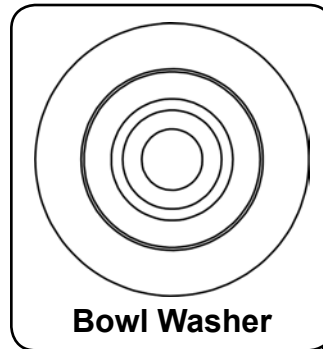

Keep all components removed from machine.

Gently flip machine onto its side and remove stock Skid Plates.

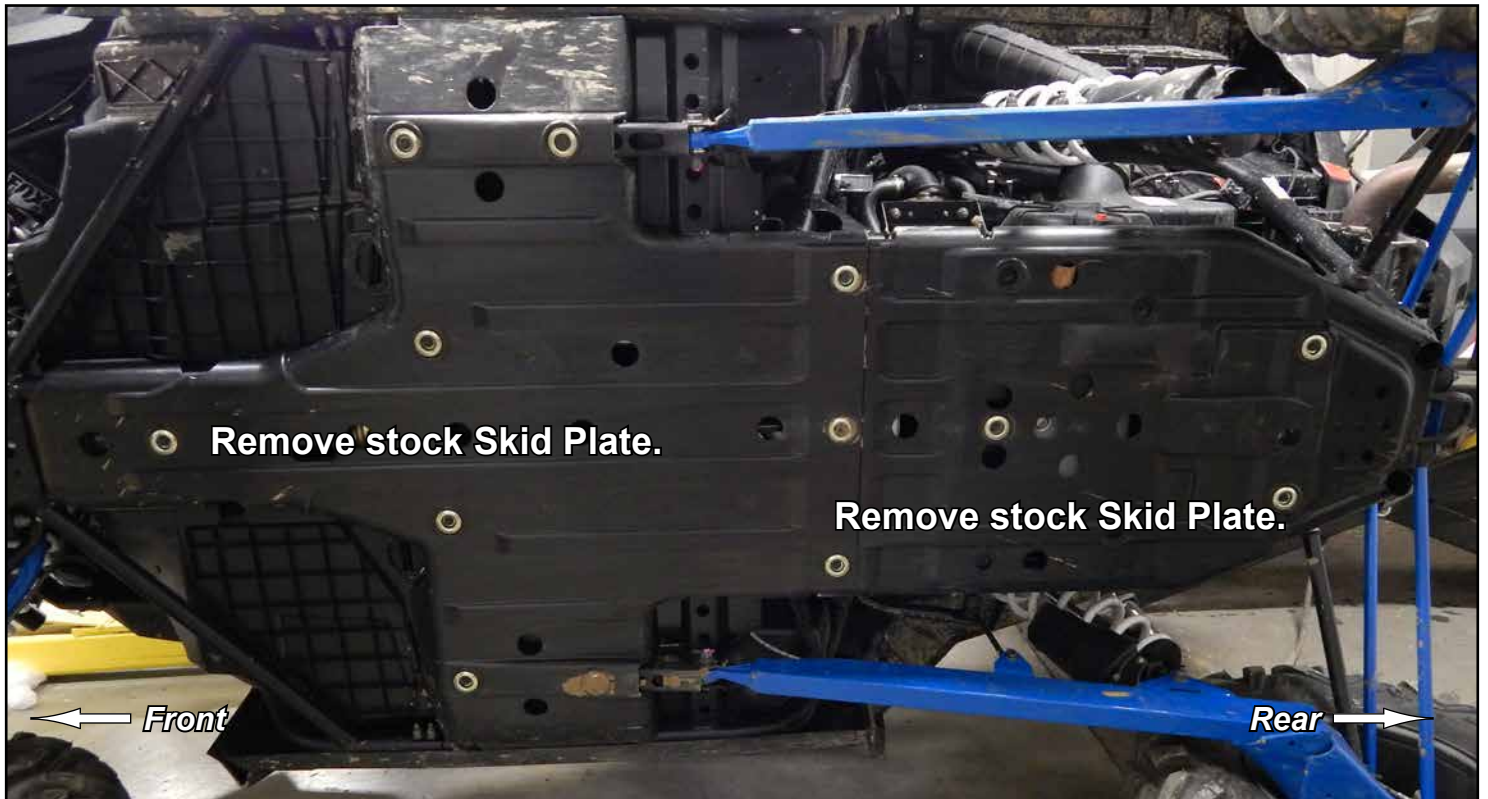



2014 - 2015 models see next page for Rear Plate (L) installation.

Install Rear Plate (L) with stock hardware and hardware shown.

2 each

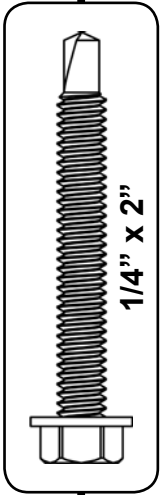

1/4" x 2"

Spacer

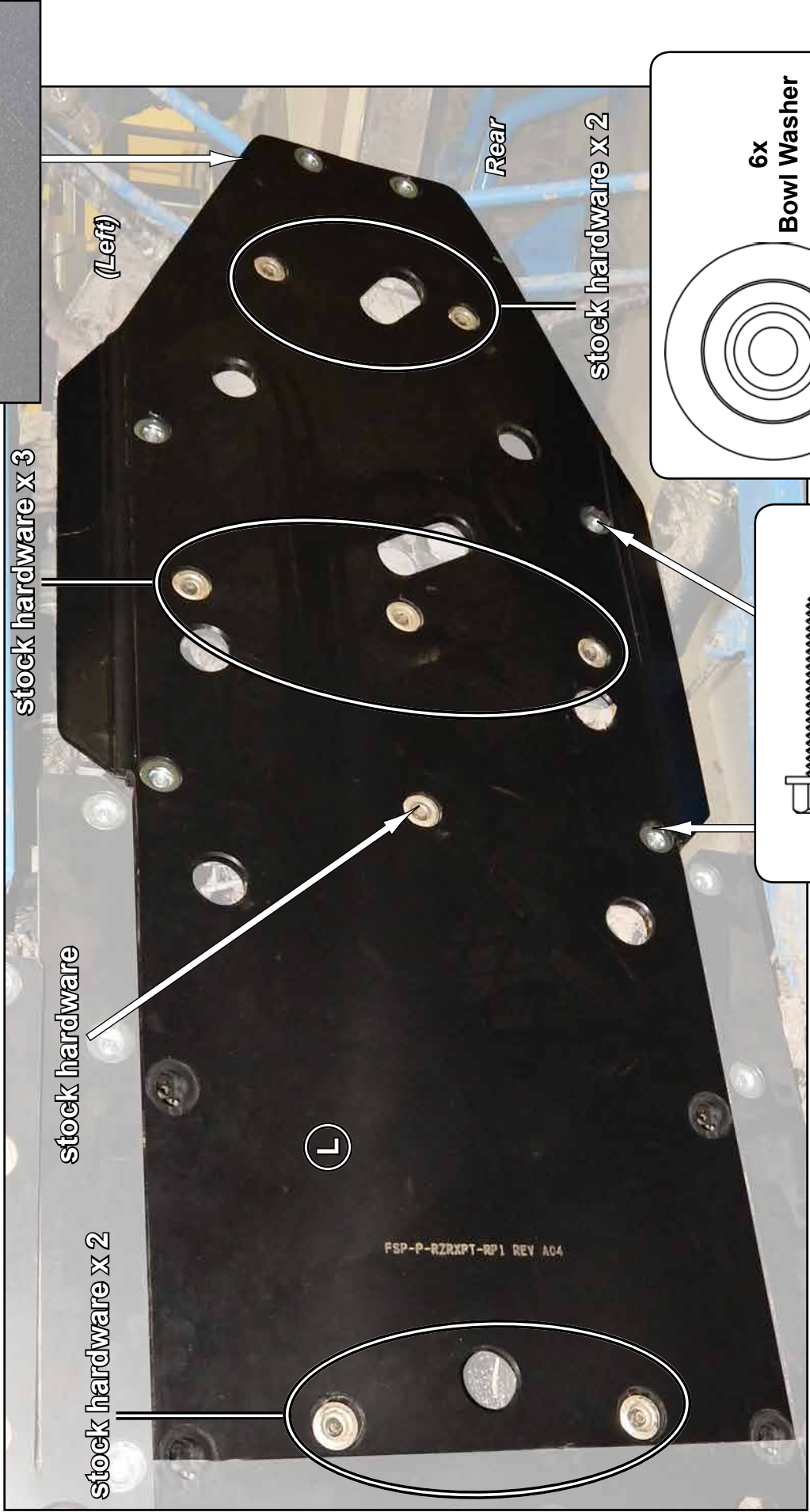
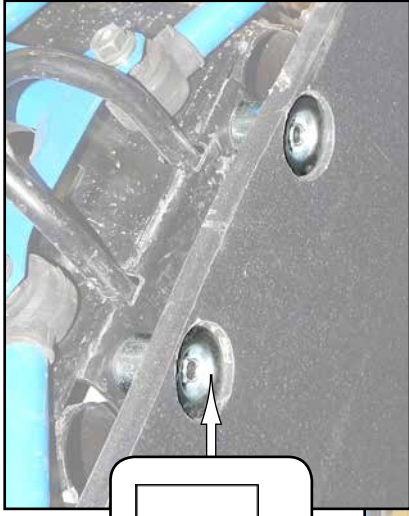

stock hardware x 2

stock hardware

stock hardware x 3

(Left)

Rear

stock hardware x 2

6x

Bowl Washer

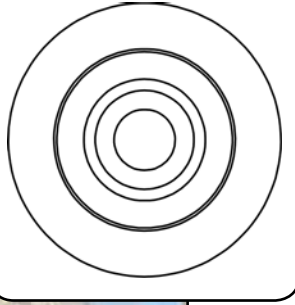

4x

1/4" x 1-1/2"

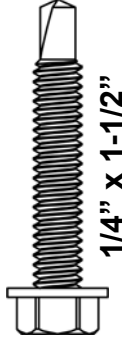

2014 - 2015 models:

(Left)

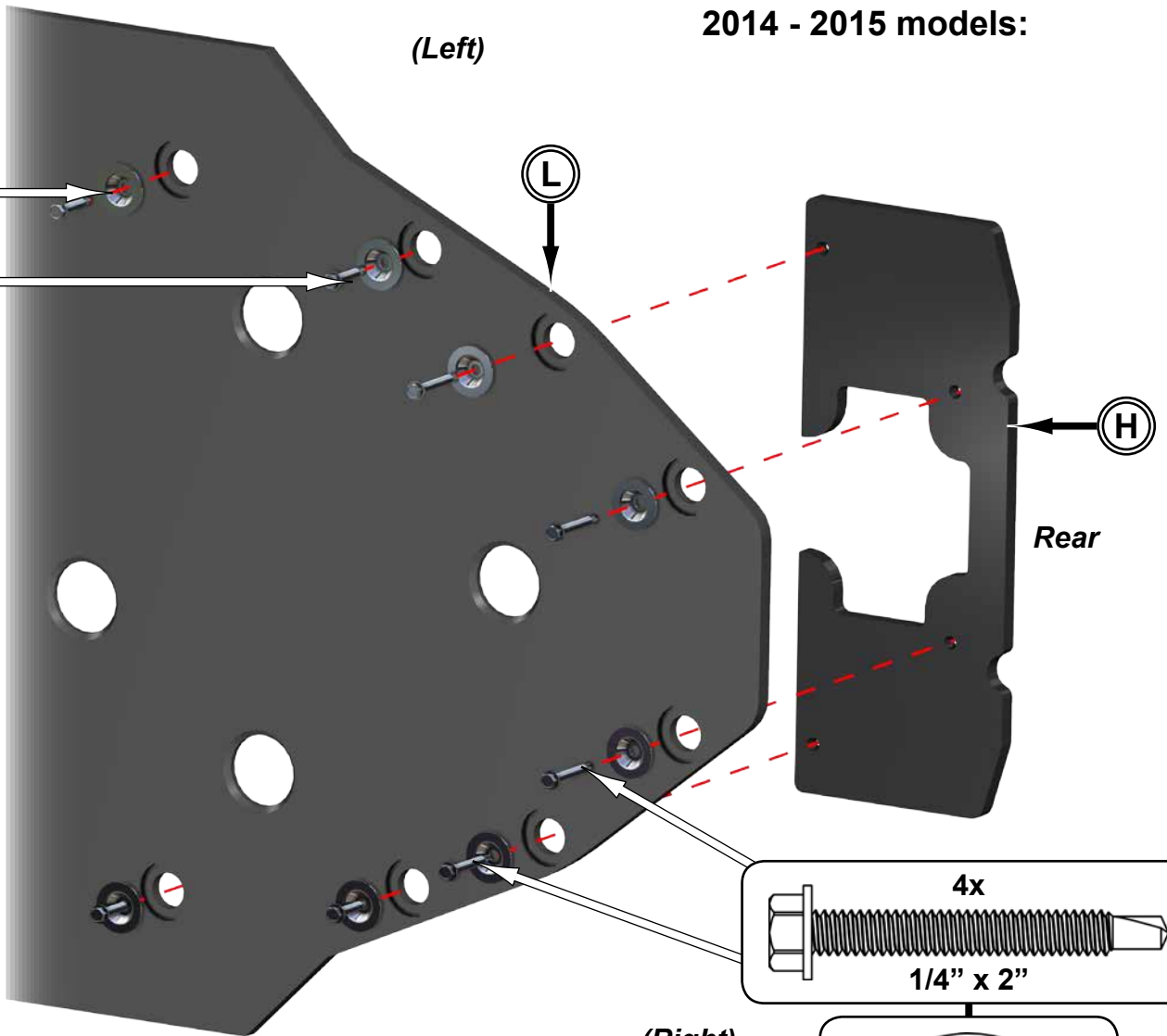
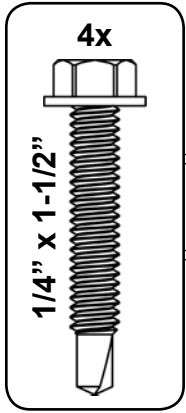

(Right)

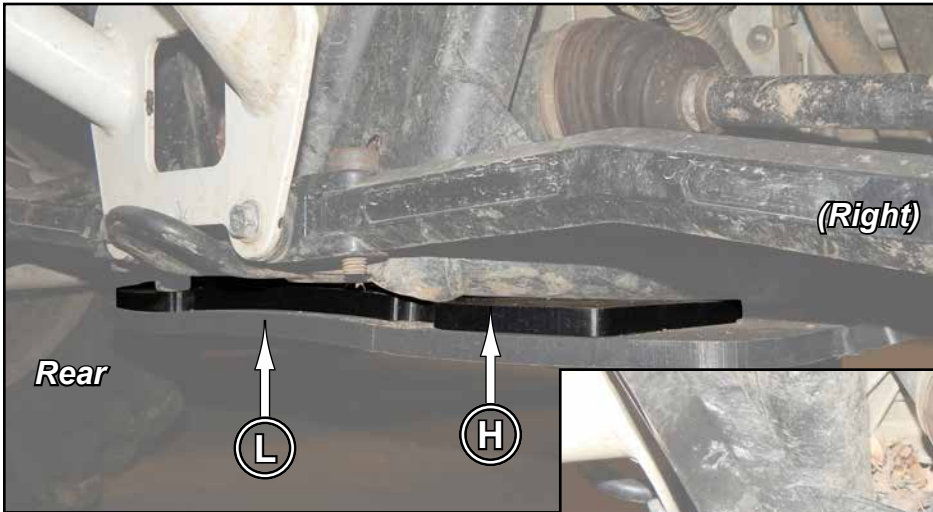
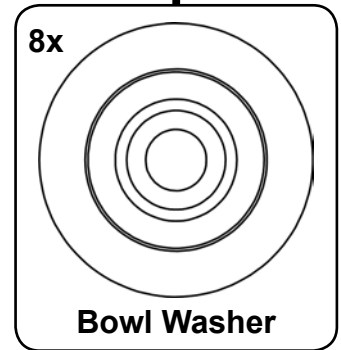

Install Middle Plate (K) to machine with hardware shown.

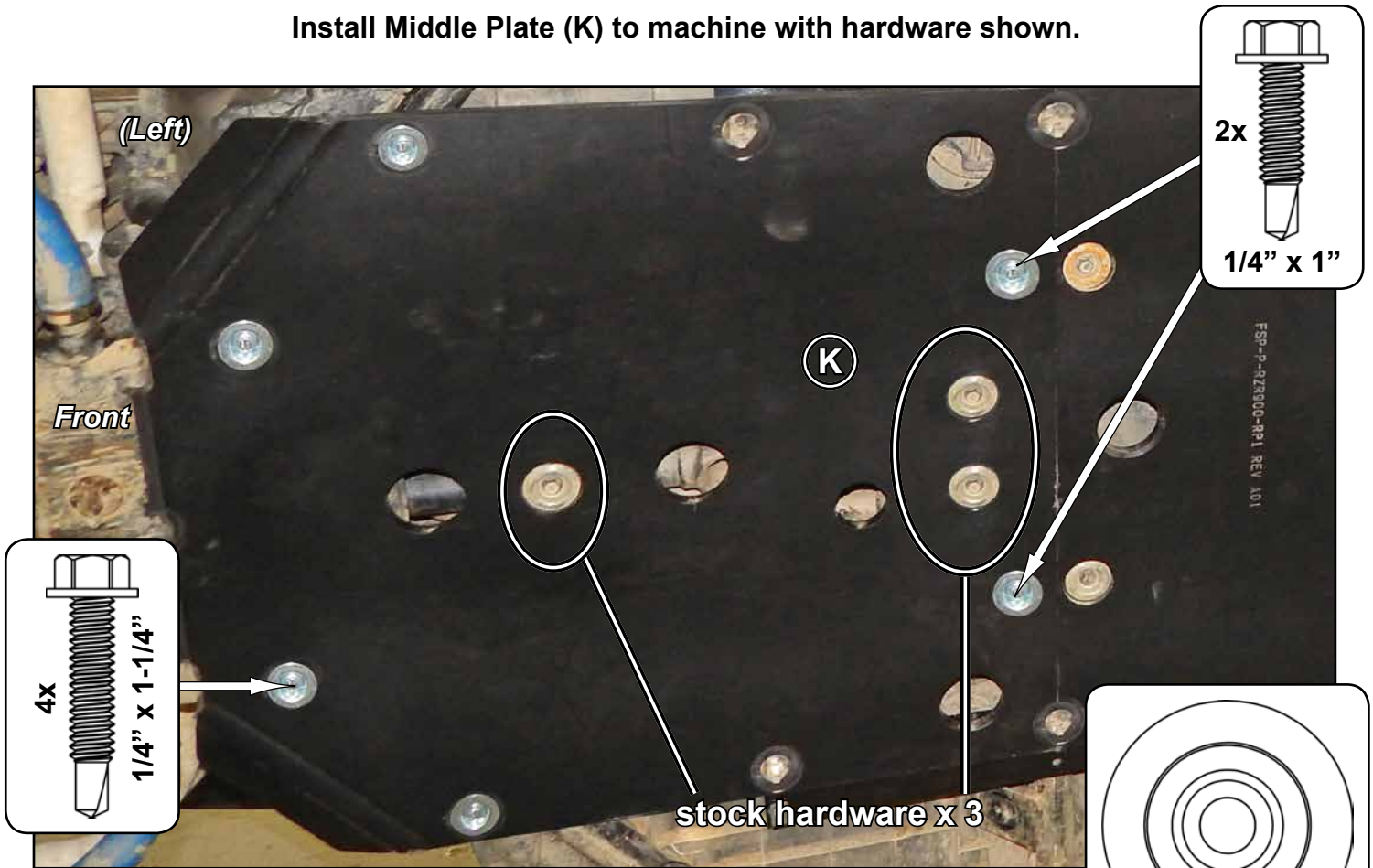

Install Front Plate (J) to machine with hardware shown.

****Do not install if SuperATV Snow Plow Mount or Frame Stiffener is installed.**

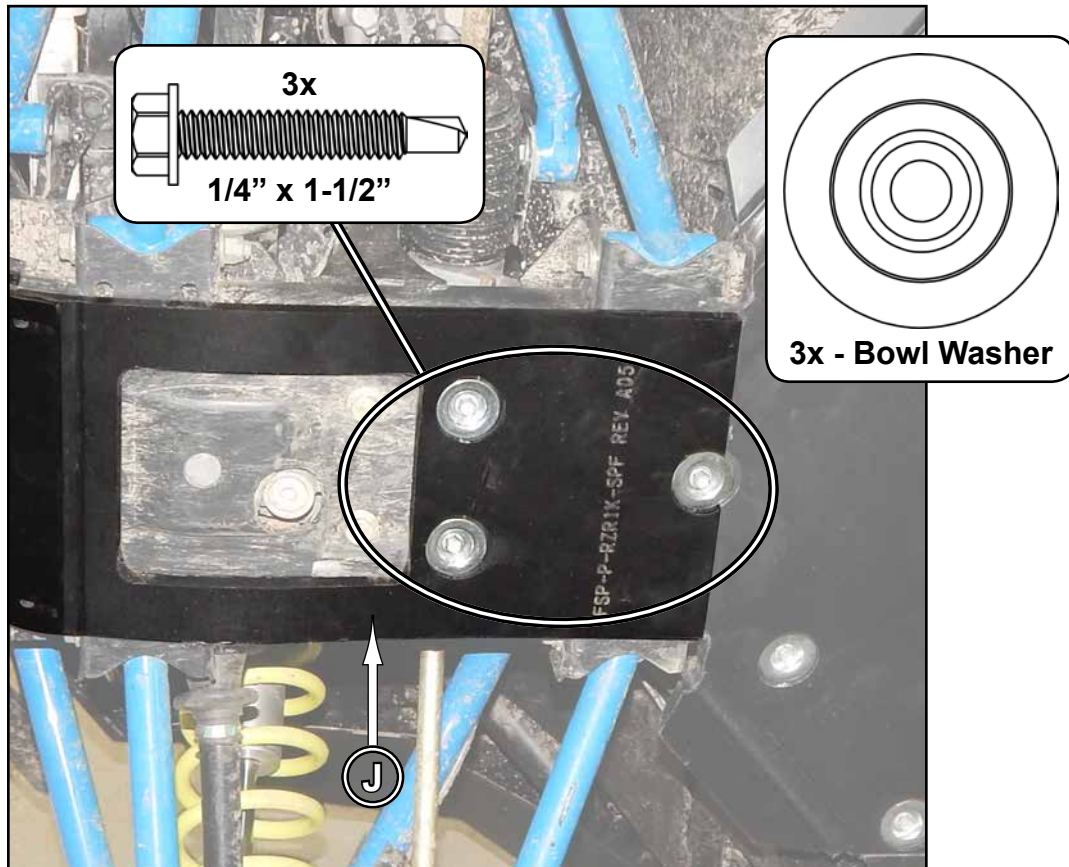

Install Bracket (F) to Middle Plate (K) and frame with hardware shown.

NOT ALL HOLES IN BRACKETS ARE USED. SEE BELOW.

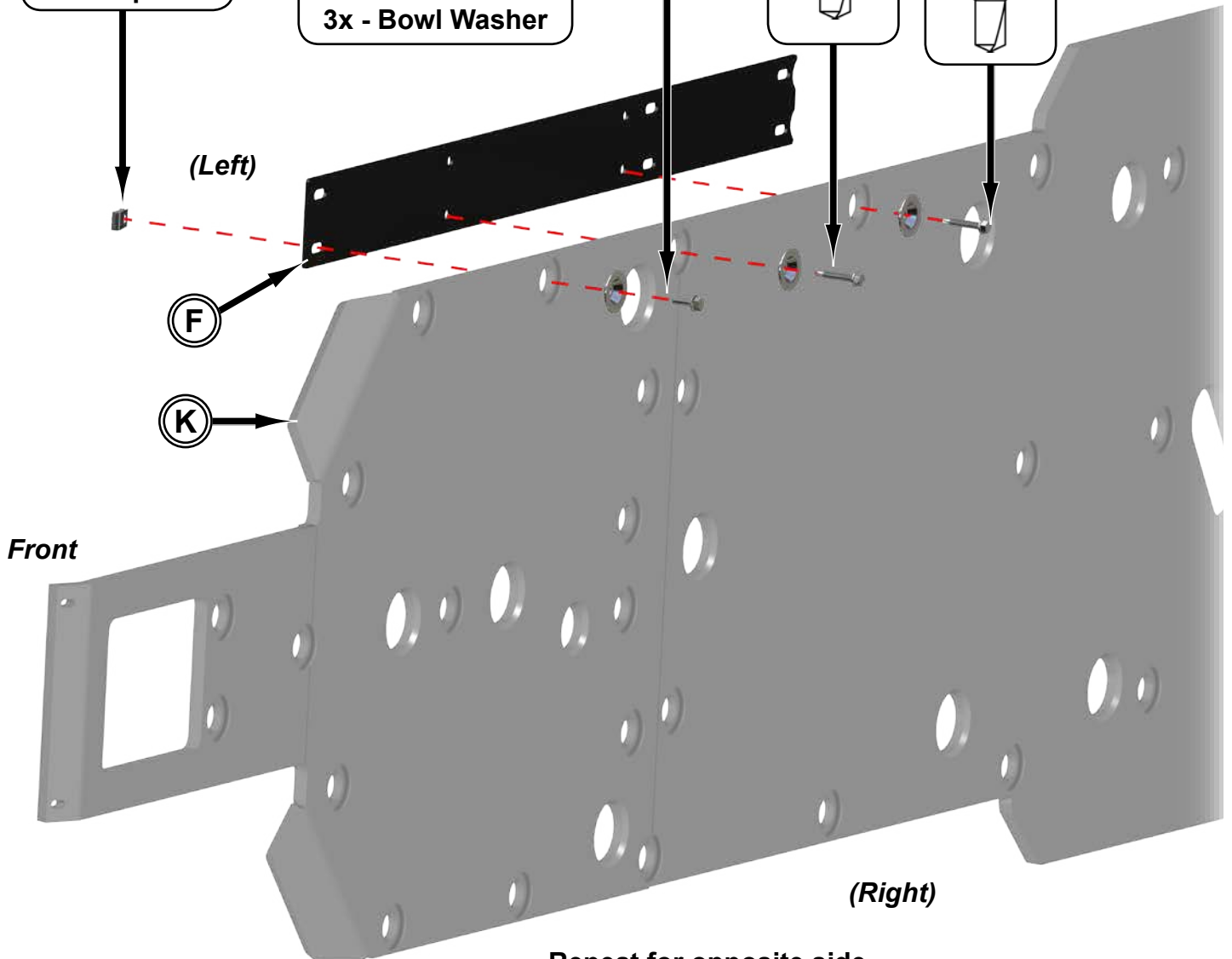
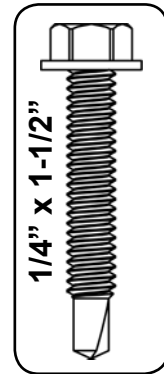
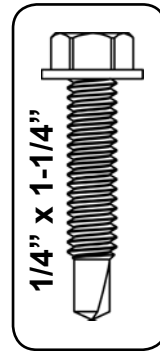
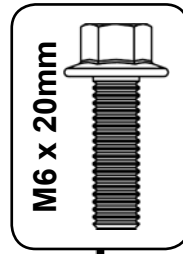
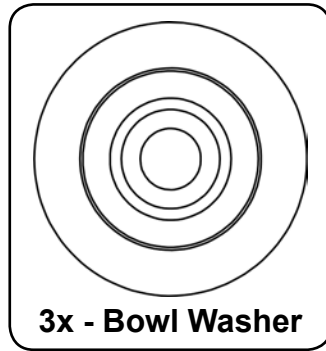
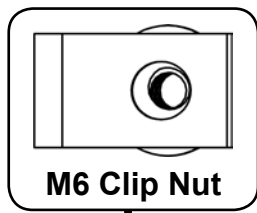

Install Left Middle Plate (E) to Bracket (F) and frame with hardware shown.

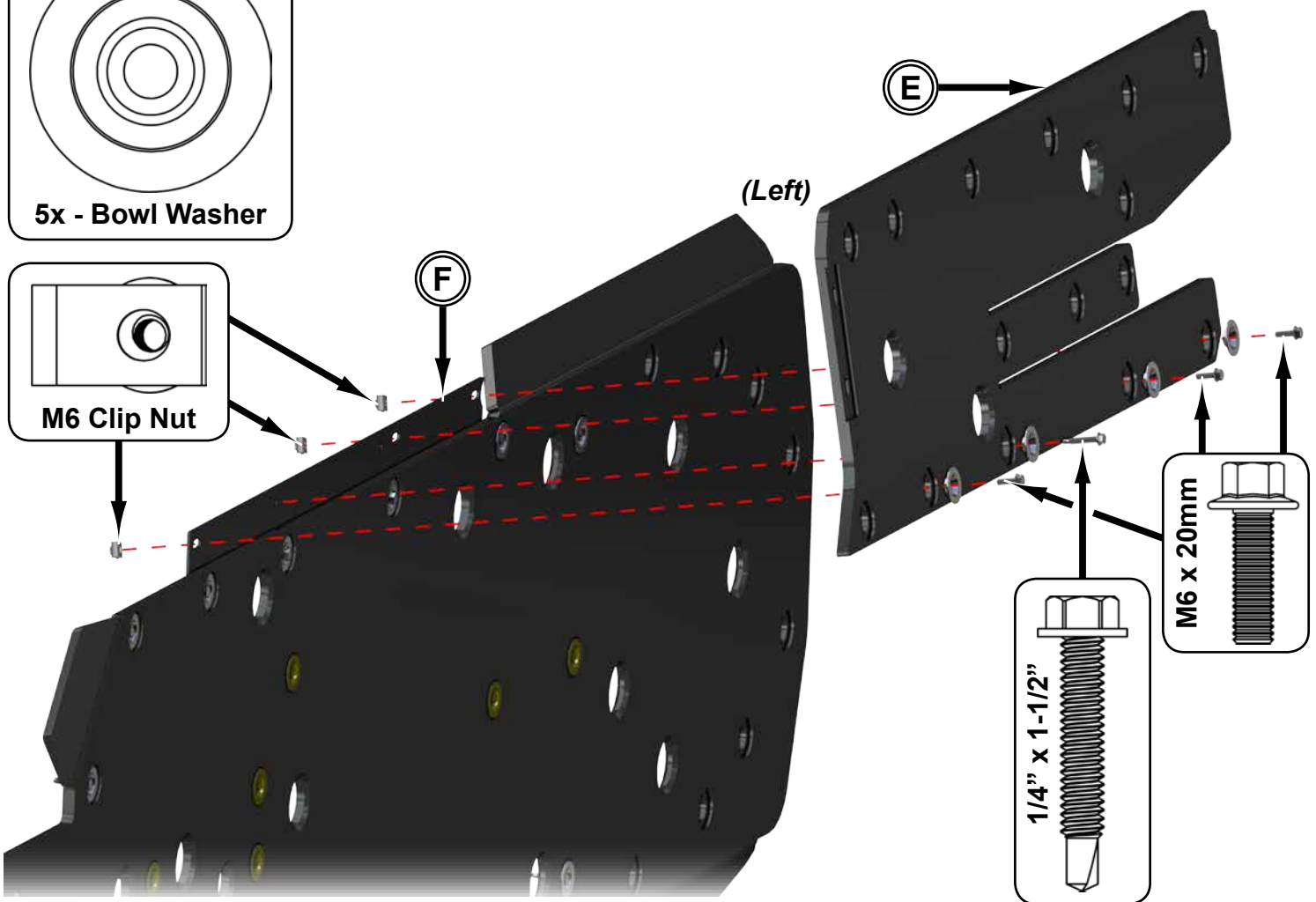
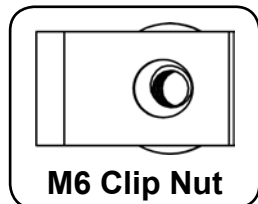
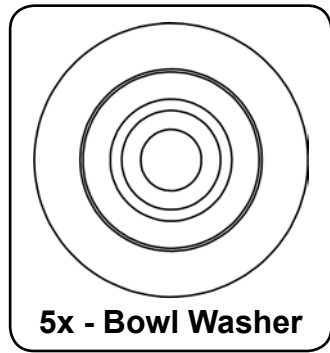

Install Left Middle Plate (E) to machine with hardware shown.

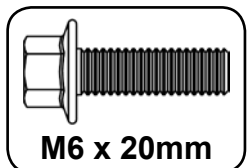
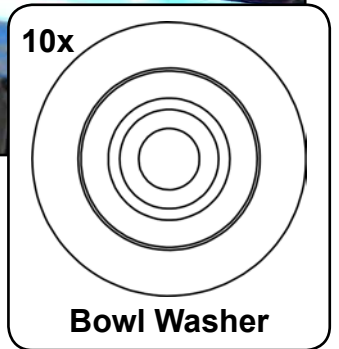
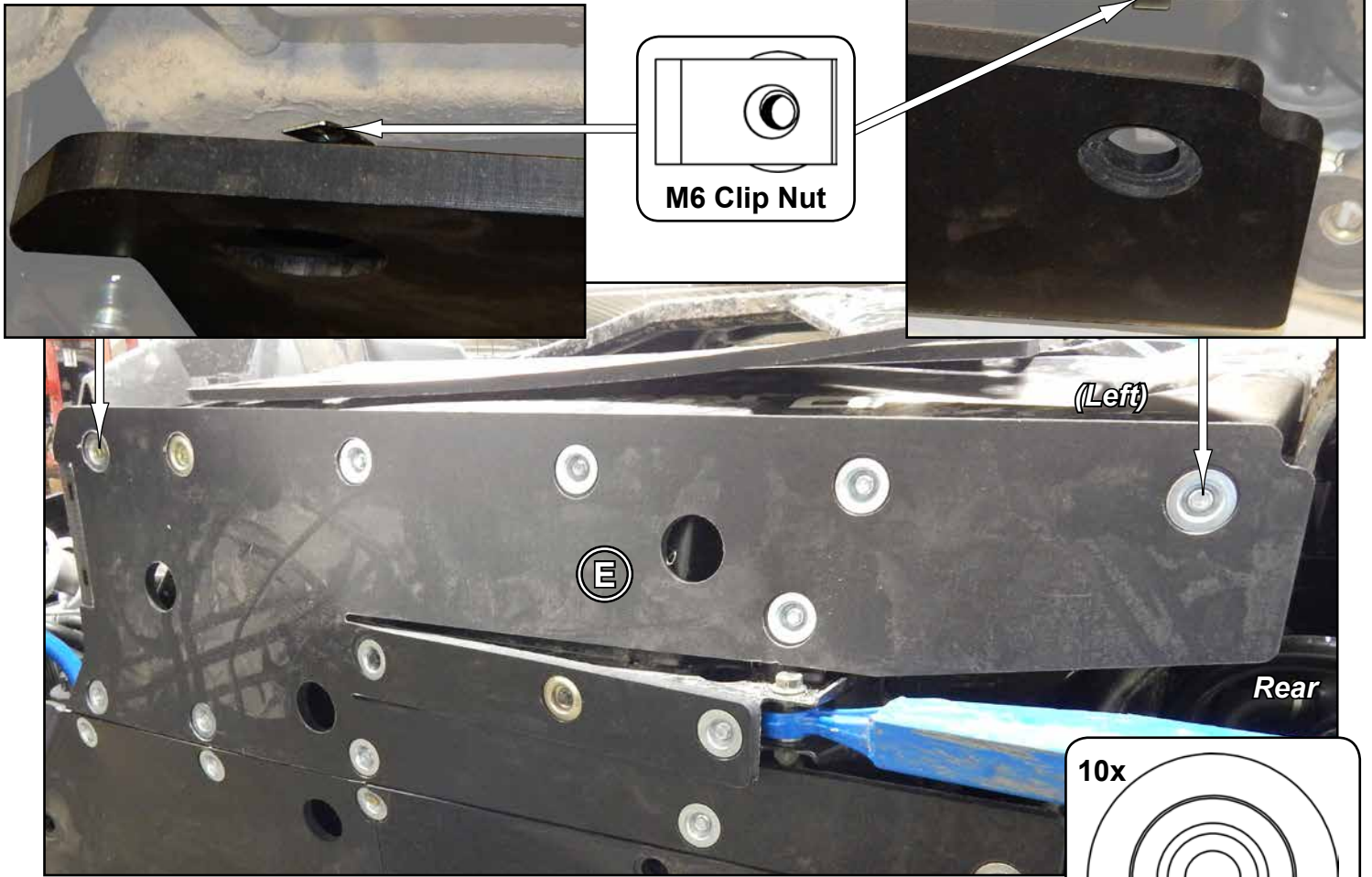

2 each

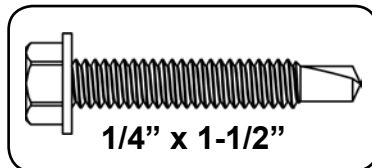
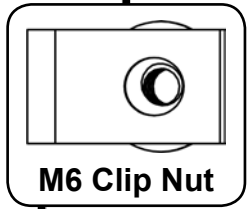

7x

(Left)

(E)

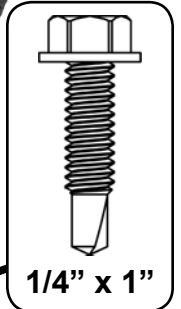

Rear

Repeat for Right Middle Plate (D).

- Install Front Metal Plate (A) to Front Plate (J) and Frame with hardware shown.

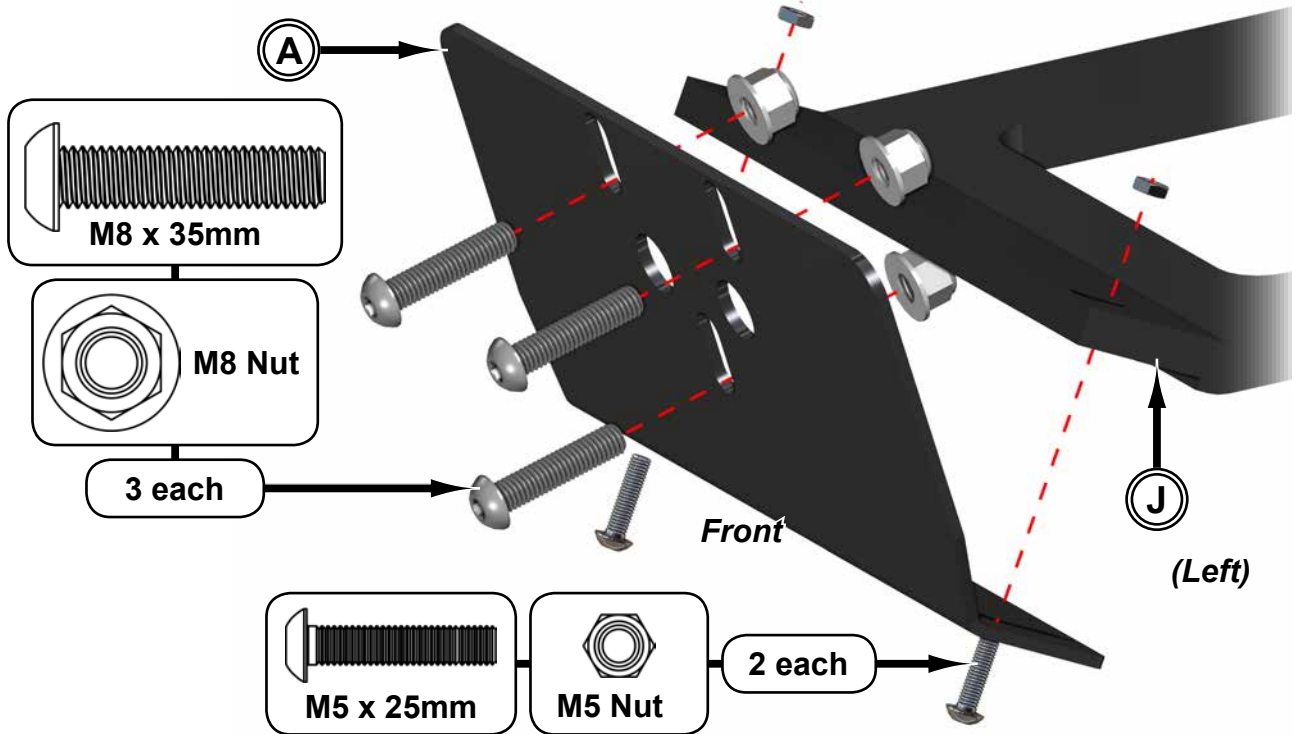

Machines with a Bumper installed, see next page for Front Metal Plate (A) installation.

- Secure Front Bumper as shown if applicable.



- Install Left Splash Guard (C) to Left Middle Plate (E) with hardware shown.
- Repeat for opposite side.

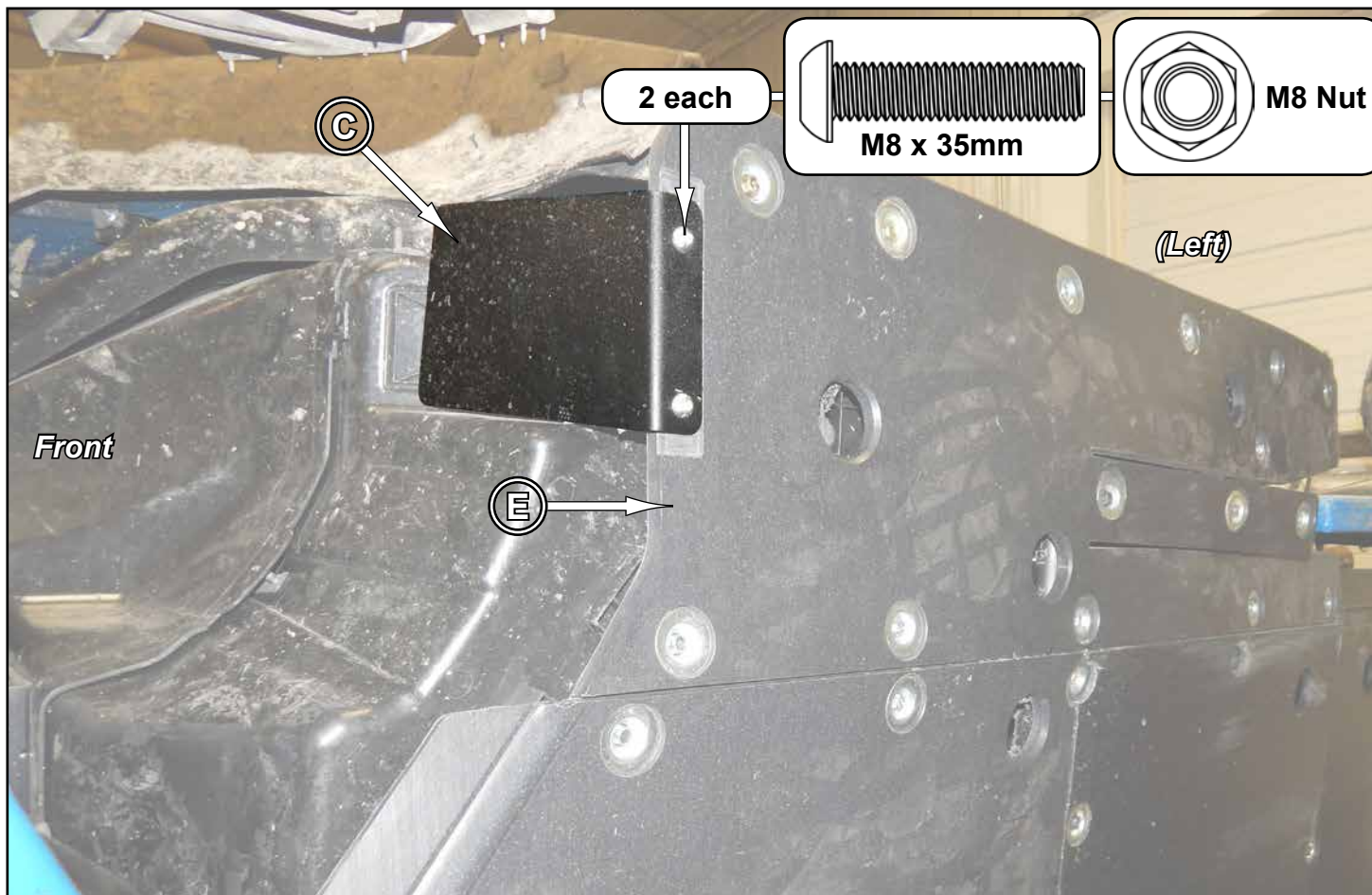

Tighten all hardware completely.