

### Kawasaki Teryx 4 Lift Kit

Item	Description	Qty
A	Front Brackets	2
B	Rear Brackets, Aft	2
C	Rear Brackets, Fore	2
D	M10-1.50 Nylock Nuts	2
E	M10-1.50 Flange Nylock Nuts	4
F	M12-1.75 Flange Nylock Nuts	6
G	M10-1.50 x 55mm Lg. Flange Head Bolts	4
H	M12-1.75 X 60mm Lg. Flange Head Bolts	2
J	M10-1.50 x 55mm Lg. HHCS	2
K	M12-1.75 X 65mm Lg. Flange Head Bolts	2
L	M12-1.75 X 80mm Lg. Flange Head Bolts	2
M	21mm Lg. Spacer	2
N	27mm Lg. Spacer	2
P	29.5mm Lg. Spacer	2

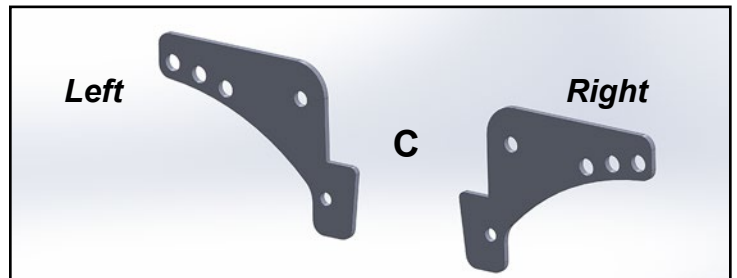
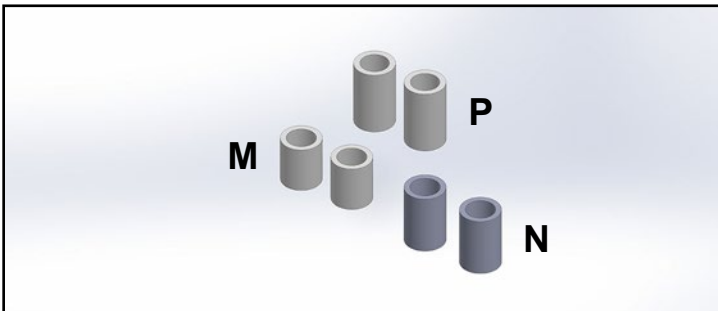
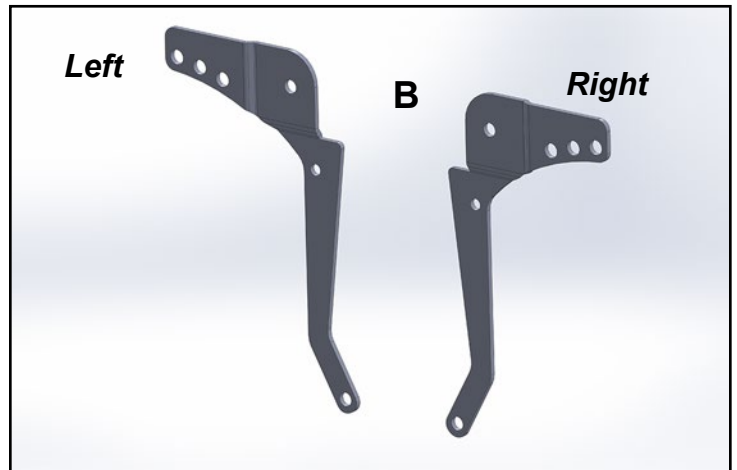
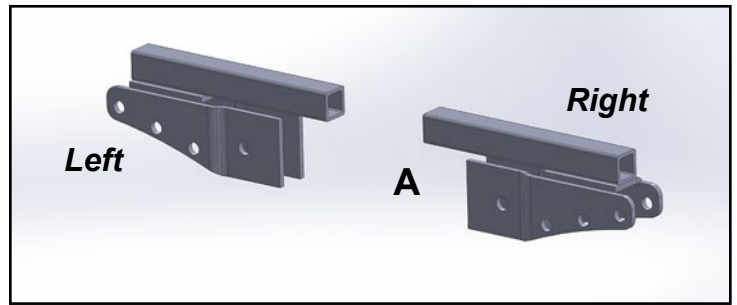

(Kit contents continue on following page)

**Read instructions and view illustrations before beginning.**

**Need help with your installation?**



sales@superatv.com



www.superatv.com



1-812-574-7777



8:00am - 9:00pm EST M-Th  
8:00am - 7:00pm EST Friday  
9:00am - 2:00pm EST Saturday

*Thank You  
For Choosing*

#### Liability Statement

SuperATV's products are designed to best fit users ATV/UTV under stock conditions. Adding, modifying, or fabricating any factory, or aftermarket, parts will void any warranty provided by SuperATV and is not recommended. SuperATV's products could interfere with other aftermarket accessories. If user has aftermarket products on machine, contact SuperATV to verify that they will work together.

Although SuperATV has thousands of satisfied customers, user should be aware that installing lift kits, long travel, or suspension kits, tires, etc will change the ride of machine and may increase maintenance and part wear. Operating any off-road machine while, or after, consuming alcohol and/or drugs increases risk of bodily harm or death. No warranty or representation is made as to this product's ability to protect user from severe injury or death. SuperATV urges operators and occupants to wear a helmet and appropriate riding gear at all times.

By purchasing and installing SuperATV products, user agrees that should damages occur, SuperATV will not be held responsible for loss of time, use, labor fees, replacement parts, or freight charges. SuperATV, nor any 3rd party, will not be held responsible for any direct, indirect, incidental, special, or consequential damages that result from any product purchased from SuperATV. The total liability of seller to user for all damages, losses, and causes of action, if any, shall not exceed the total purchase price paid for the product that gave rise to the claim.

SuperATV will warranty only parts provided by SuperATV. Any damage or problems with OEM housings, bearings, seals, or other manufacturers products will not be covered by SuperATV. SuperATV parts and products are not warranted if item was not installed properly, misused, or modified.

(Kit contents continued)

Item	Description	Qty
D	M10-1.50 Nylock Nuts	2
E	M10-1.50 Flange Nylock Nuts	4
F	M12-1.75 Flange Nylock Nuts	6
G	M10-1.50 x 55mm Lg. Flange Head Bolts	4
H	M12-1.75 X 60mm Lg. Flange Head Bolts	2
J	M10-1.50 x 55mm Lg. HHCS	2
K	M12-1.75 X 65mm Lg. Flange Head Bolts	2
L	M12-1.75 X 80mm Lg. Flange Head Bolts	2

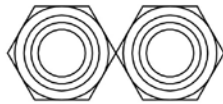

**D**

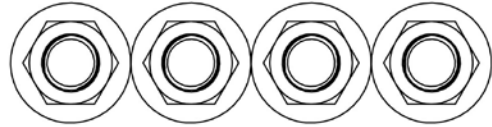

**E**

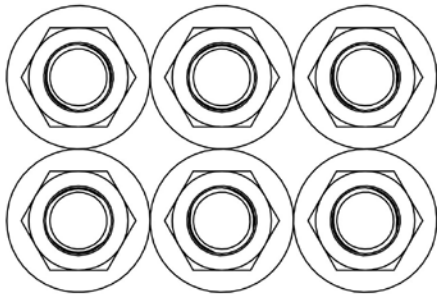

**F**

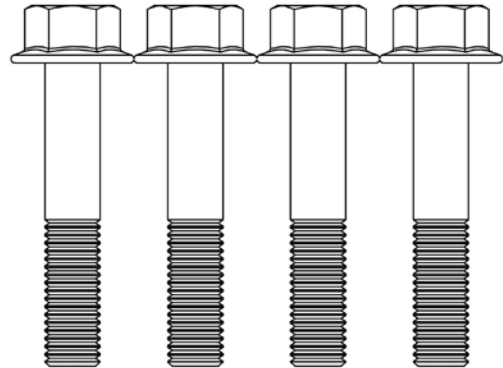

**G**

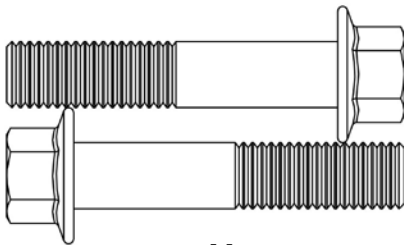

**H**

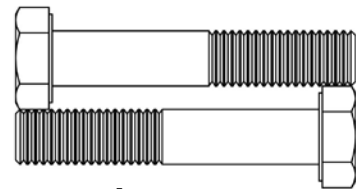

**J**

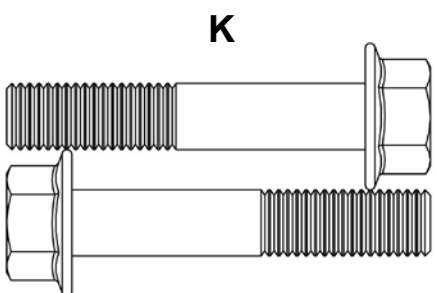

**K**

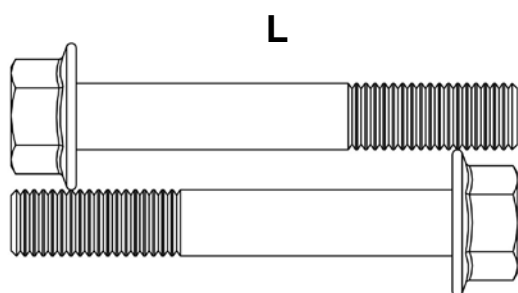

**L**

Do not tighten hardware completely unless noted.  
Keep stock hardware for reuse.

## FRONT

1. Raise Front of machine off ground, secure with jack stands, and remove Wheels.
2. Remove Shocks from Frame. See Fig. 1.
3. Install Front Bracket (A) into Frame. See Fig. 2.
  - Secure with M10-1.50 x 55mm Lg. Flange Head Bolt (G), M10-1.50 Flange Nylock Nut (E), and 21mm Lg. Spacer (M). See Figs. 2 - 2b.
4. See Lift Settings and reinstall Shock with stock hardware. See Fig. 2b.
5. Repeat steps for opposite side.

## REAR

6. Raise Rear of machine off ground, secure with jack stands, and remove Wheels.
7. Remove Shocks from machine.
8. Remove rear stock hardware from Upper A-Arms. See Figs. 3 - 3a.
9. Install Rear Brackets (B)(C) to stock Shock Mount with M12-1.75 X 65mm Lg. Flange Head Bolt (K), 27mm Lg. Spacer (N), and M12-1.75 Flange Nylock Nut (F). See Figs. 4 - 4b.
  - Secure to Frame with M12-1.75 X 80mm Lg. Flange Head Bolt (L) and M12-1.75 Flange Nylock Nut (F). See Figs. 4 - 4b.
  - Join Brackets (B)(C) with M10-1.50 x 55mm Lg. HHCS (J), 29.5mm Lg. Spacer (P), and M10-1.50 Nylock Nut (D). See Figs. 4 - 4b.
10. See Lift Settings and reinstall Shock with stock hardware or M12-1.75 X 60mm Lg. Flange Head Bolt (H) and M12-1.75 Flange Nylock Nut (F). See Fig. 4b. **Shocks must be flipped when reinstalling!**
11. Repeat steps for opposite side.

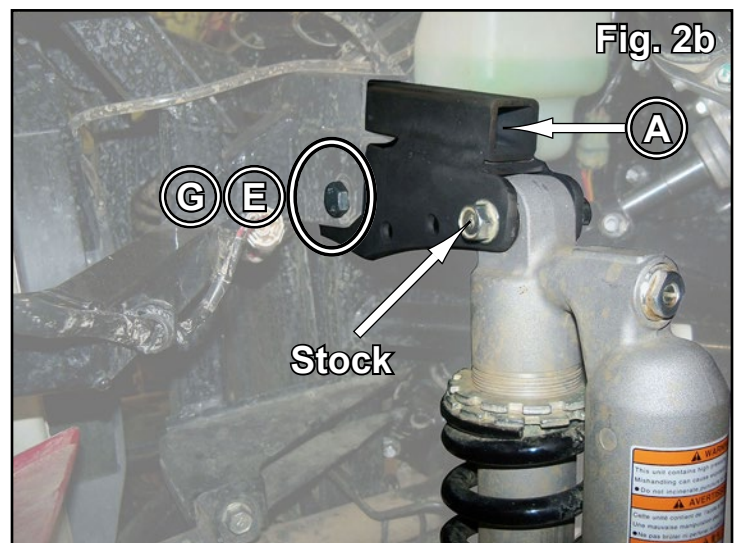
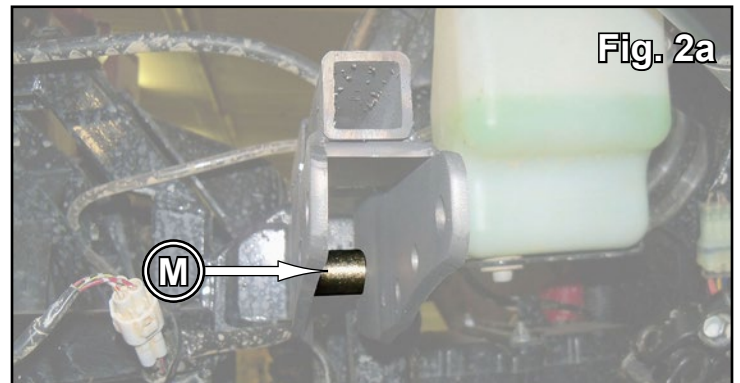
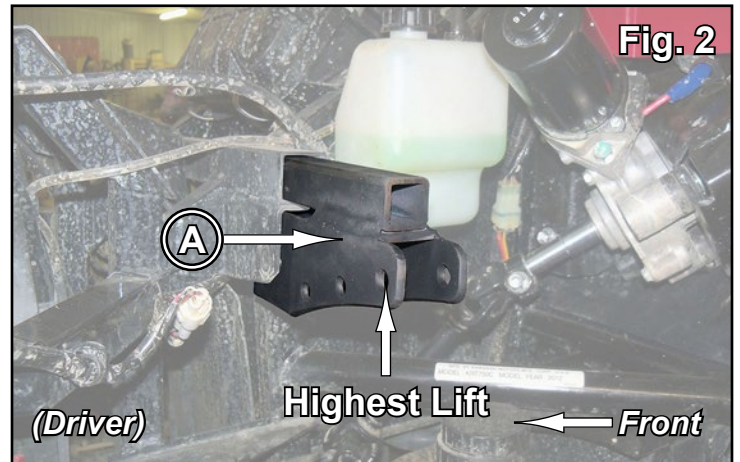
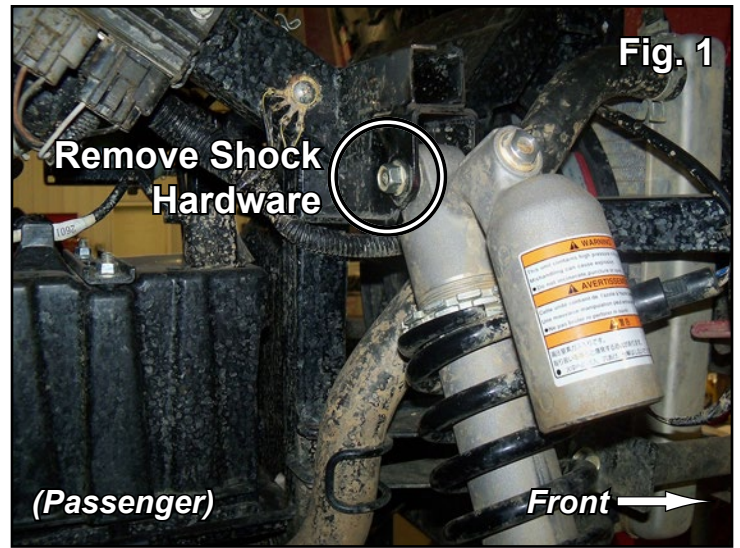

(installation illustrations continue on following page)

