

INSTALLATION INSTRUCTIONS
Roof: for Polaris Ranger Midsize

- This item is not returnable if the protective film has been removed.
- Test fit to the cage to confirm fitment before removing film.
- Do not discard packaging until product has been successfully installed.

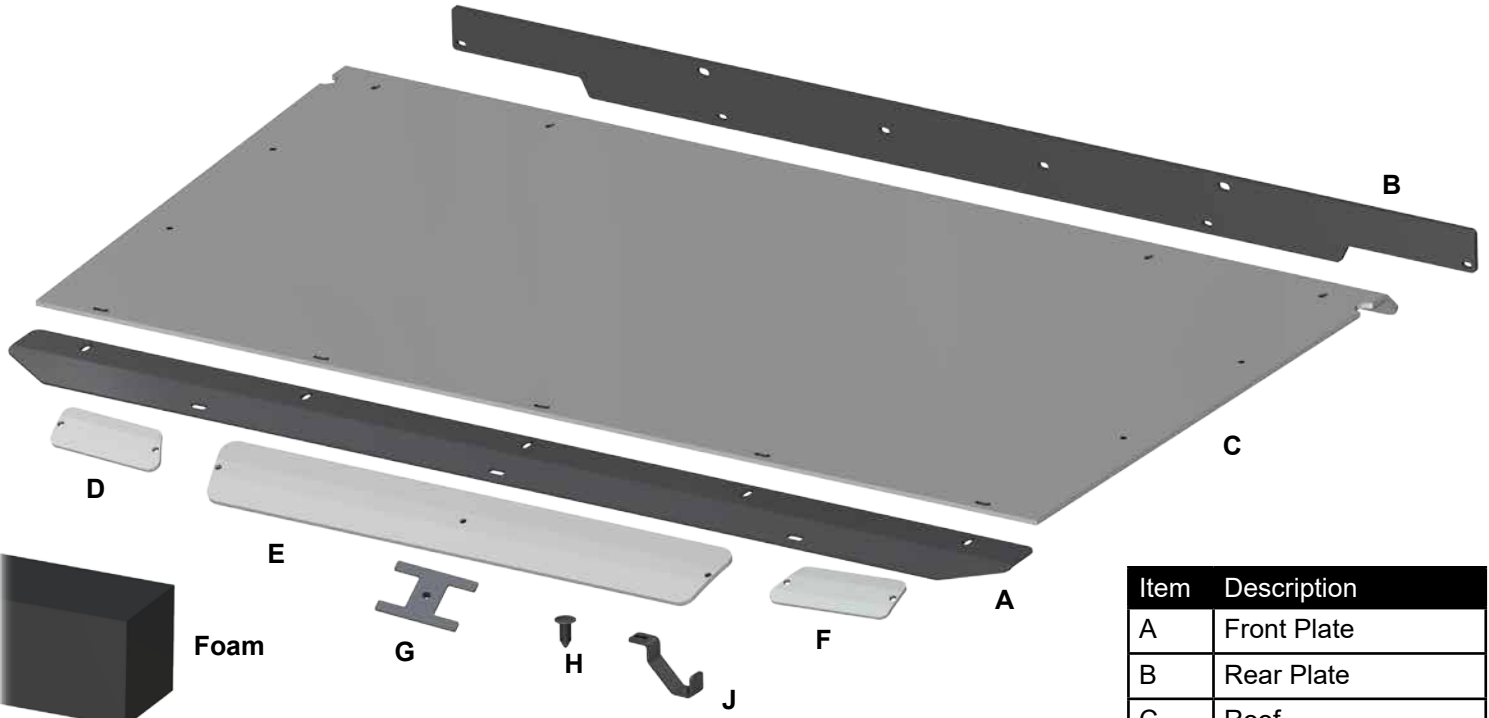

| Item | Description |
|------|--------------------|
| A | Front Plate |
| B | Rear Plate |
| C | Roof |
| D | Right Panel |
| E | Center Panel |
| F | Left Panel |
| G | Center Panel Mount |
| H | Shank x 4 |
| J | Bracket x 4 |

(Disregard any remaining components)

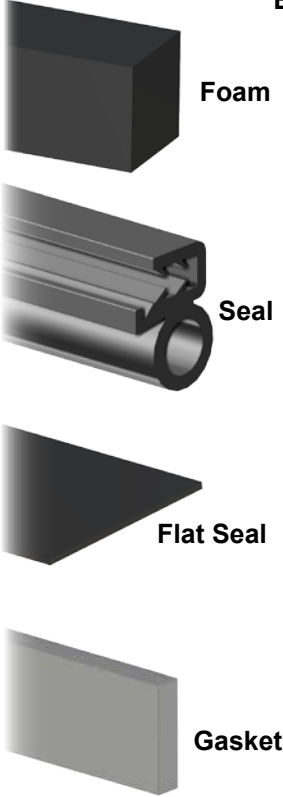

Roof Cleaning:

- Do not use Rain-X[®], Plexus[®] or any other protector, wax, or polish.
 - Do not use window cleaning fluids (Windex, 409, etc) or any solvents (gasoline, denatured alcohol, acetone, etc).
 - Never use abrasive cleaners, abrasive pads, or gritty cloths.
1. Thoroughly rinse Roof to float off dirt and mud.
 2. Using a soft cloth, or microfiber cloth, clean Roof with warm water and a gentle detergent. Baby shampoo, rubbing alcohol, or hand washing soap can also be used.
 3. To prevent water spots, use a chamois to blot Roof dry.

Need help with your installation?

sales@superatv.com
 www.superatv.com
 1-855-743-3427
 8:00am - 8:00pm EST M-Th
 8:00am - 7:00pm EST Friday
 9:00am - 2:00pm EST Saturday

Read instructions and view illustrations before beginning.

Thank You
 For Choosing
SUPERATV.COM[®]



Rubber must face Roof when installing Sealing Washers



- Install provided Seal to sides of Roof (C).

To ease installation, soak Seal in hot water before cutting or installing to increase flexibility.

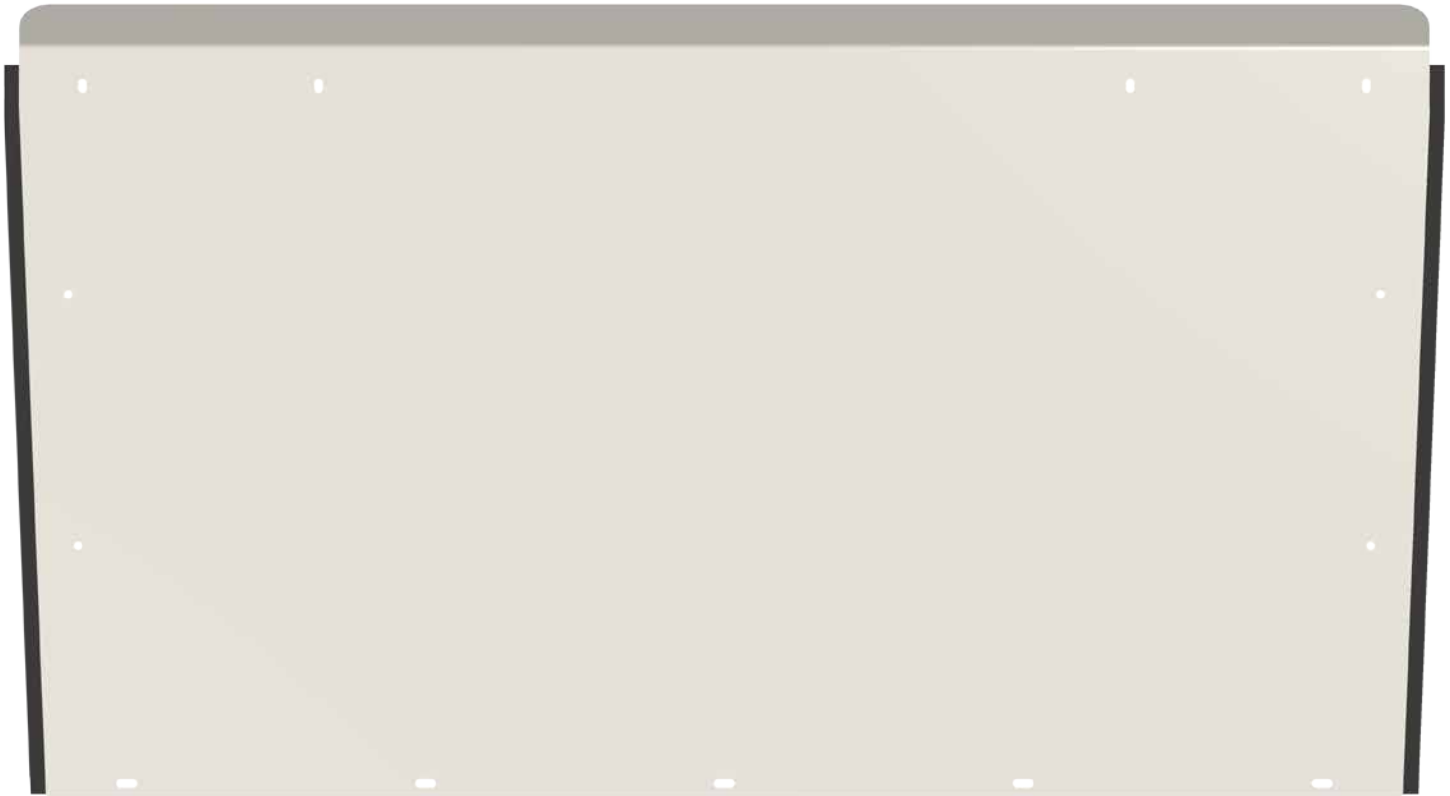

Seal

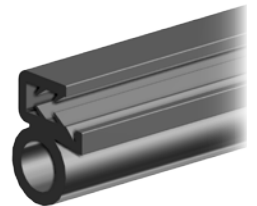

- Install Foam to Roof (C) in location shown.

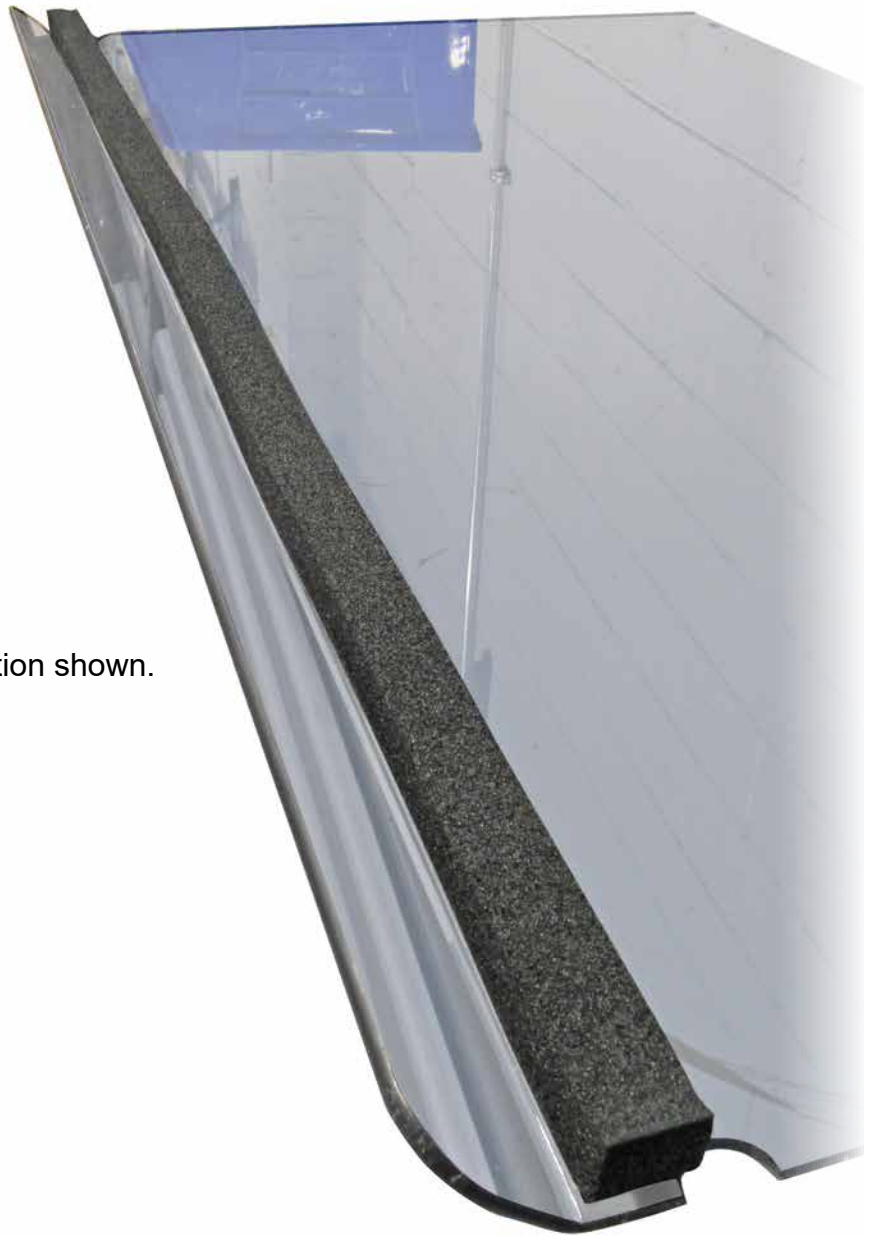

Foam

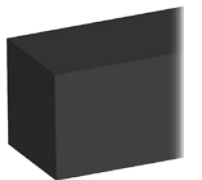

When installing components, do not tighten any hardware completely unless noted.

- Install Rear Plate (B) to Frame with hardware shown; tighten hardware.

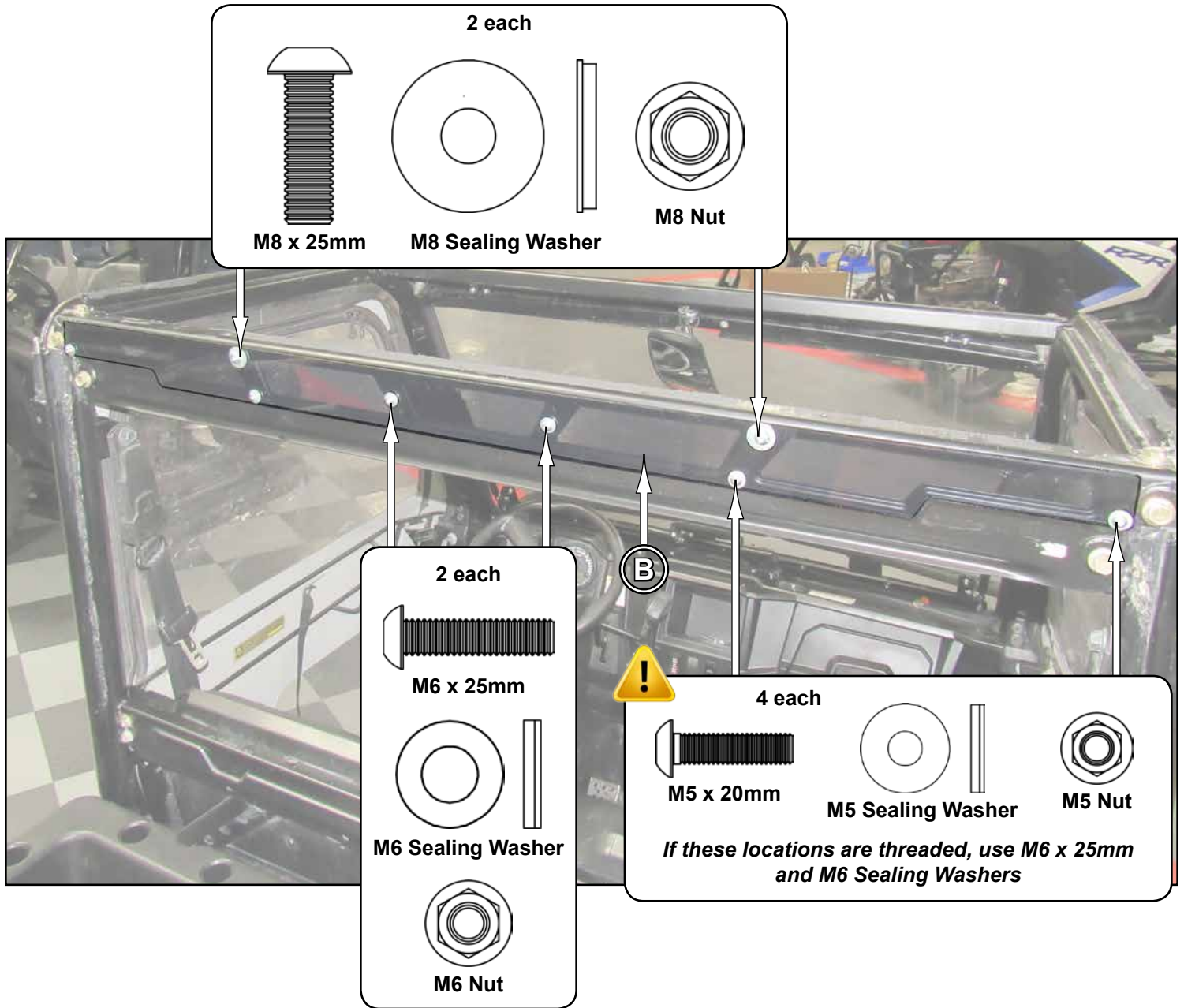

- If applicable, plug holes in Frame with provided Shanks (H).

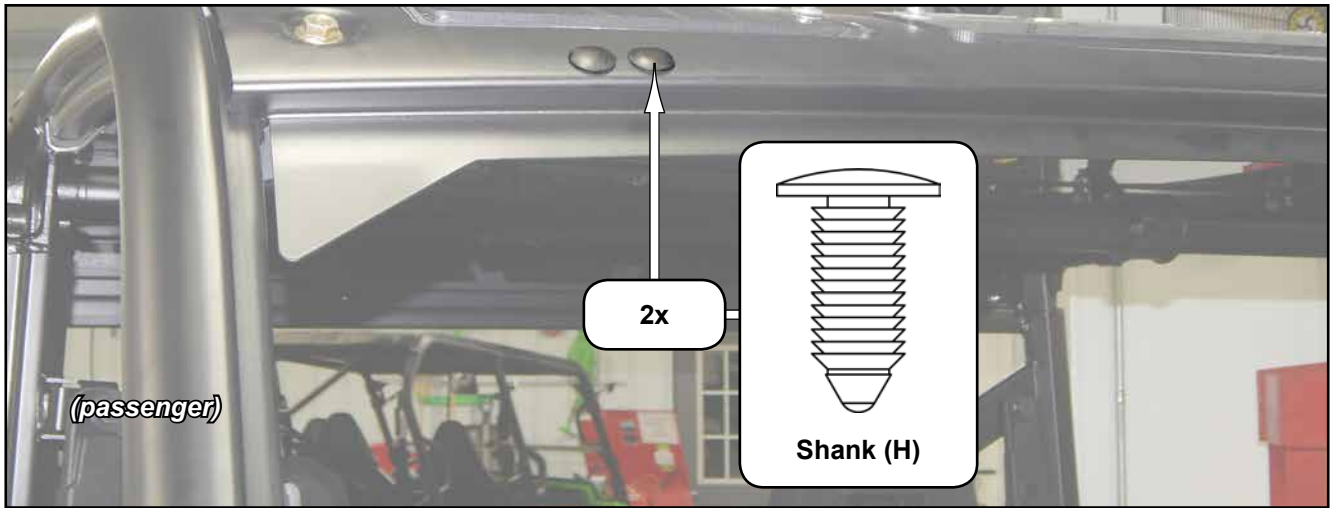

- Place Left Panel (F) onto Frame and align with stock hole.
- Mark and drill new hole. Hole should be large enough for Ø6mm bolt.
- Repeat for all Panels.
- **NOTE: Center Panel location on Frame may not have a stock hole to locate.**

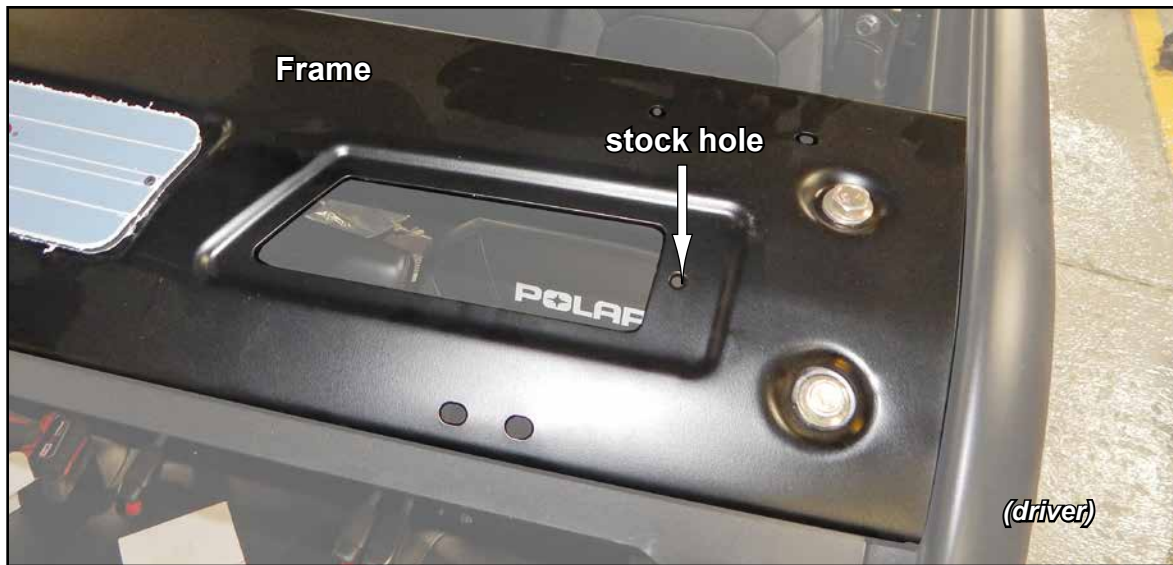

- Install provided Gasket around edges of all cutouts.



- Secure Panels (D-F) to Frame with hardware shown; tighten hardware.



7 each



M6 x 25mm



M6 Sealing Washer



M6 Nut

- Center Panel Mount (G) goes against Frame *inside* vehicle and secures with Center Panel (E) hardware.

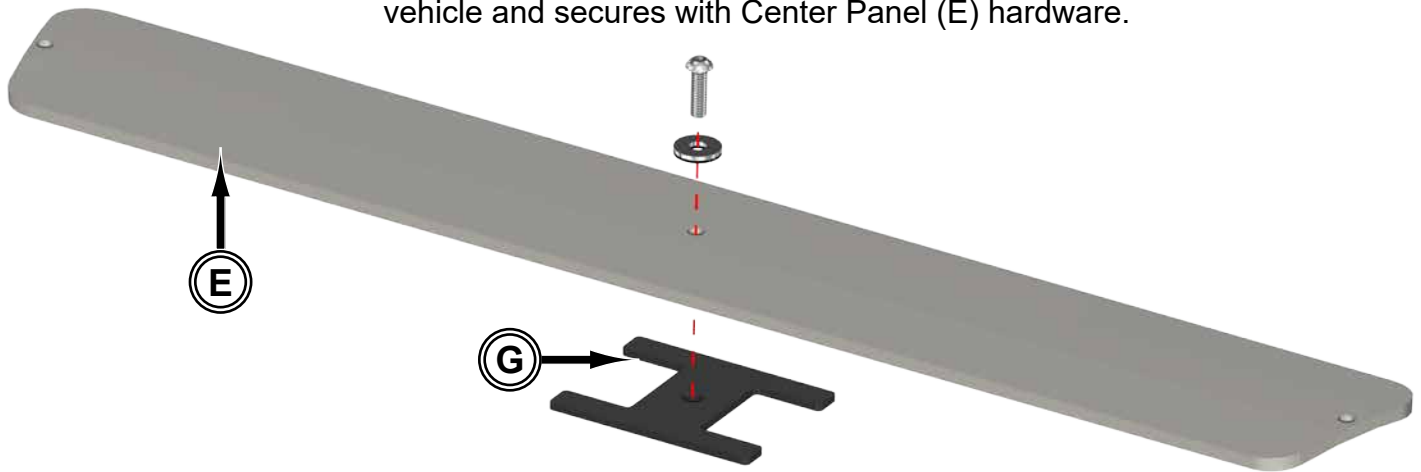

- Place Roof (C) onto machine and secure rear to Frame with hardware shown.

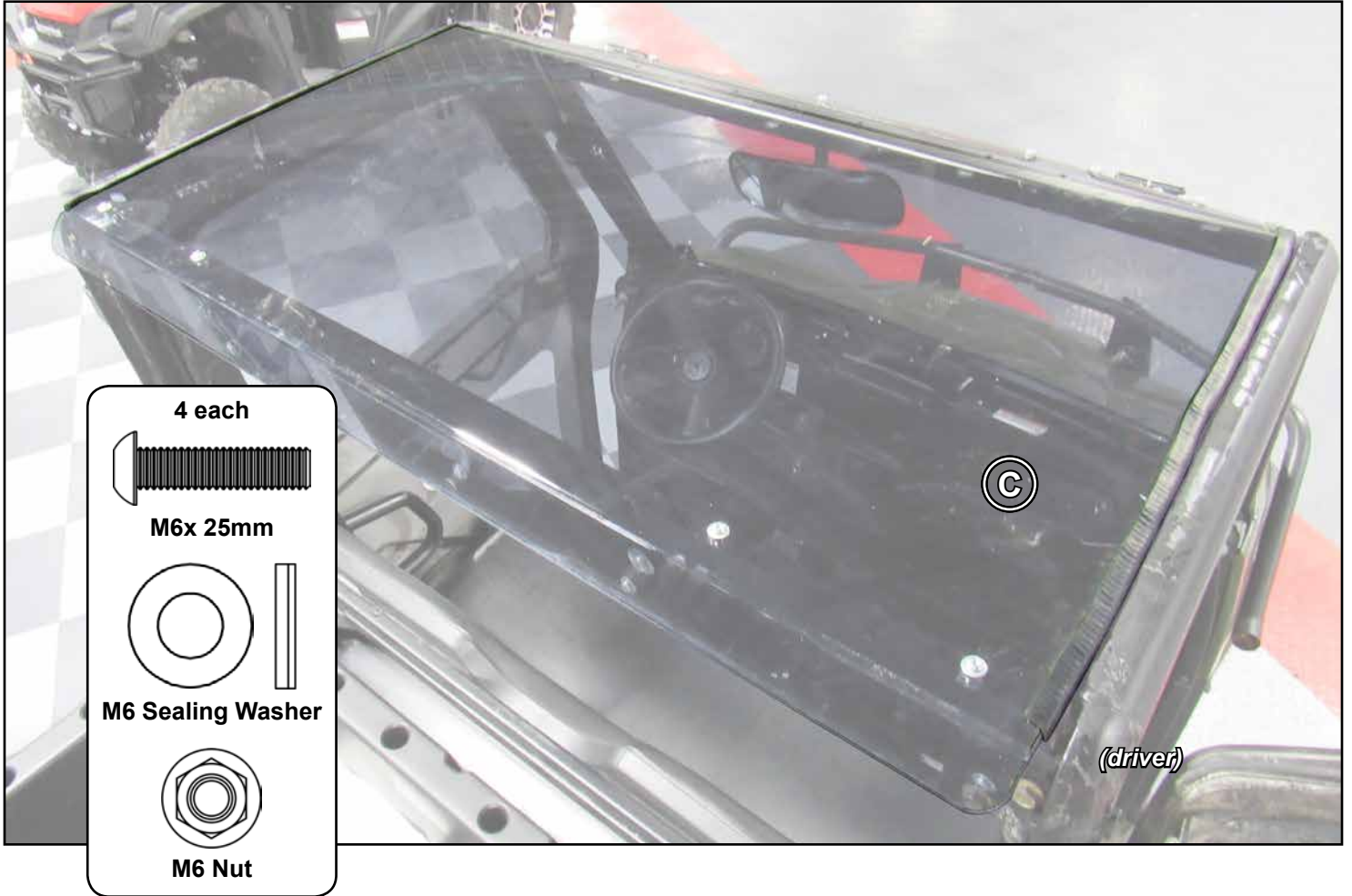

- Secure Roof (C) to Frame with Front Plate (A) and hardware shown.

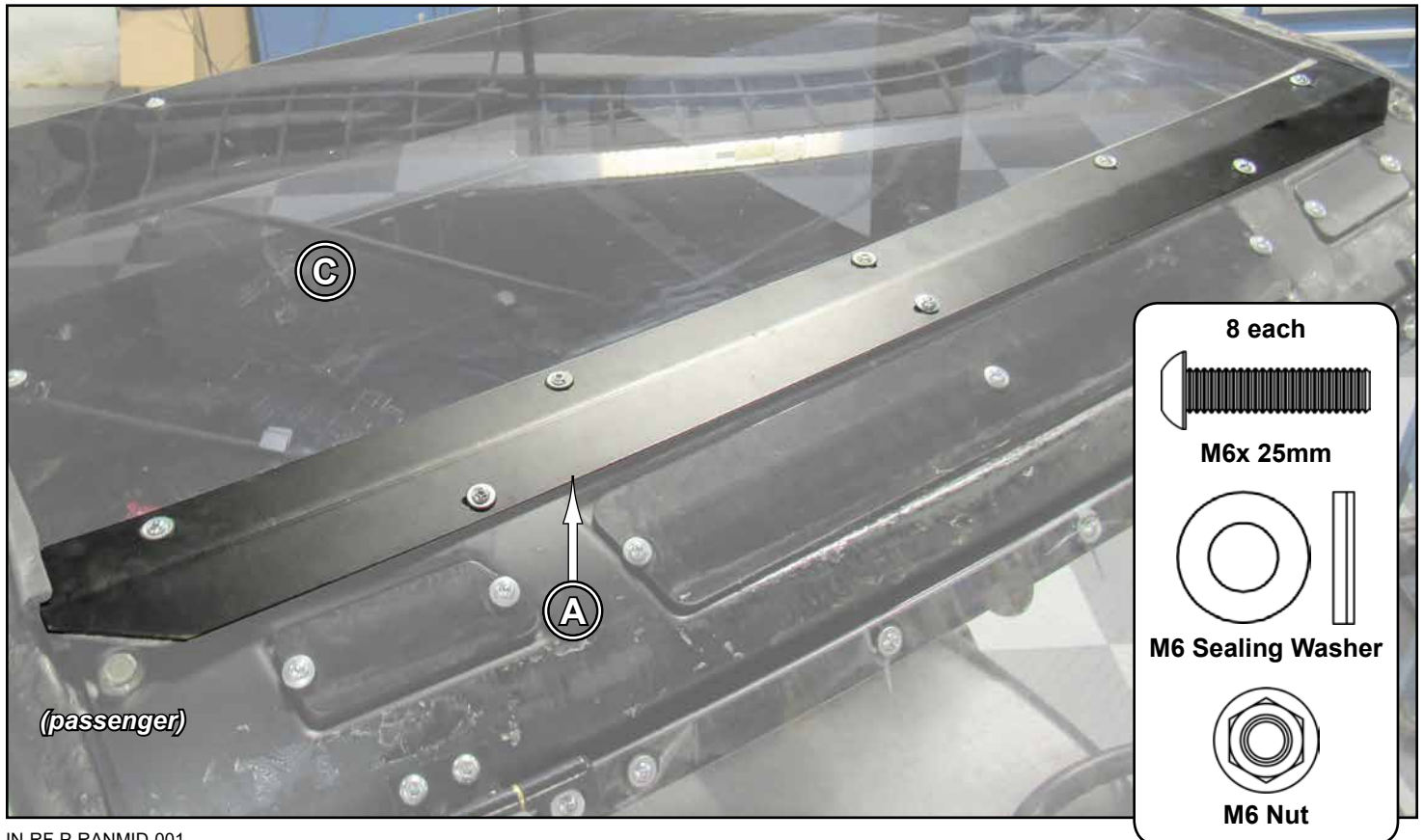

- Install Brackets (J) to Roof with hardware shown. Brackets (J) must engage around Frame as shown.

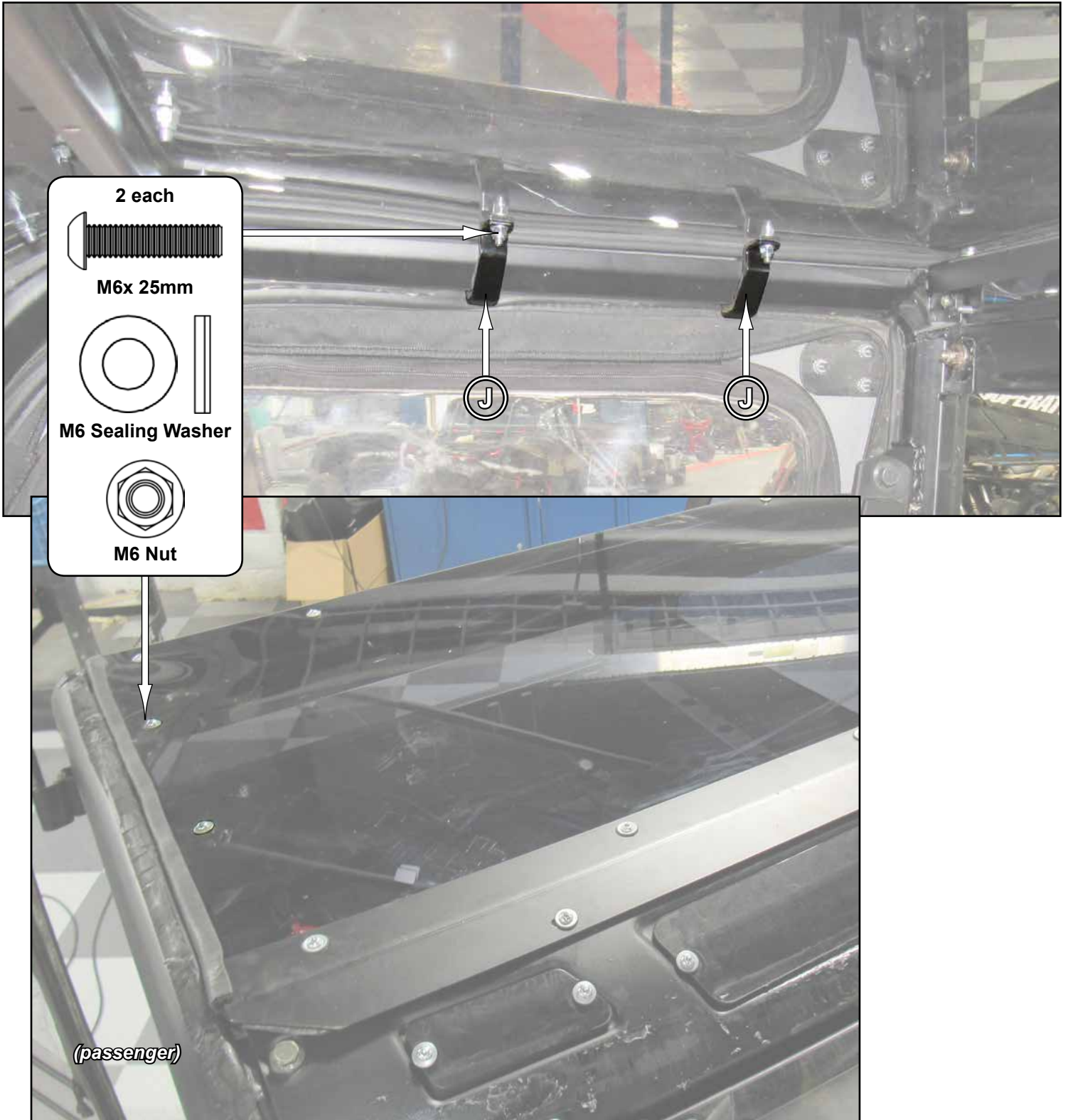

tighten hardware

Liability Statement

SuperATV's® products are designed to best fit user's ATV/UTV under stock conditions. Adding, modifying, or fabricating any factory or aftermarket parts will void any warranty provided by SuperATV® and is not recommended. SuperATV's® products could interfere with other aftermarket accessories. If user has aftermarket products on machine, contact SuperATV® to verify that they will work together.

Although SuperATV® has thousands of satisfied customers, user should be aware that installing lift kits, long travel, or suspension kits, tires, etc. will change the ride of machine and may increase maintenance and part wear. Operating any off-road machine while, or after, consuming alcohol and/or drugs increases risk of bodily harm or death. No warranty or representation is made as to this product's ability to protect user from severe injury or death. SuperATV® urges operators and occupants to wear a helmet and appropriate riding gear at all times.

By purchasing and installing SuperATV® products, user agrees that should damages occur, SuperATV® will not be held responsible for loss of time, use, labor fees, replacement parts, or freight charges. SuperATV®, nor any 3rd party, will not be held responsible for any direct, indirect, incidental, special, or consequential damages that result from any product purchased from SuperATV®. The total liability of seller to user for all damages, losses, and causes of action, if any, shall not exceed the total purchase price paid for the product that gave rise to the claim.

SuperATV® will warranty only parts provided by SuperATV®. Any damage or problems with OEM housings, bearings, seals, or other manufacturers' products will not be covered by SuperATV®. SuperATV® parts and products are not warranted if item was not installed properly, misused, or modified.

Installing, adding, modifying, or fabricating any factory or aftermarket product to your ATV/UTV may violate certain local, state, and federal laws. Be advised that laws vary depending on town, city, county, state, etc. Use of certain products on public streets, roads, or highways may be in violation law. The Buyer is solely and exclusively legally and personally responsible for any violation of the law by the installation or use of the product. You must abide by all local, state, and federal laws, including but not limited to vehicle safety, traffic laws, and ordinances. It is your responsibility to know the laws and how they apply to you.

The Buyer is responsible to fully understand the capability and limitations of his/her vehicle according to manufacturer specifications, warnings and instructions and agrees to hold SuperATV® harmless from any damage resulting from failure to adhere to such specifications, warnings and/ or instructions. The Buyer is also responsible to obey all applicable federal, state, and local laws and ordinances when operating his/her vehicle while using this product, and the Buyer agrees to hold SuperATV® harmless from any violation thereof.